

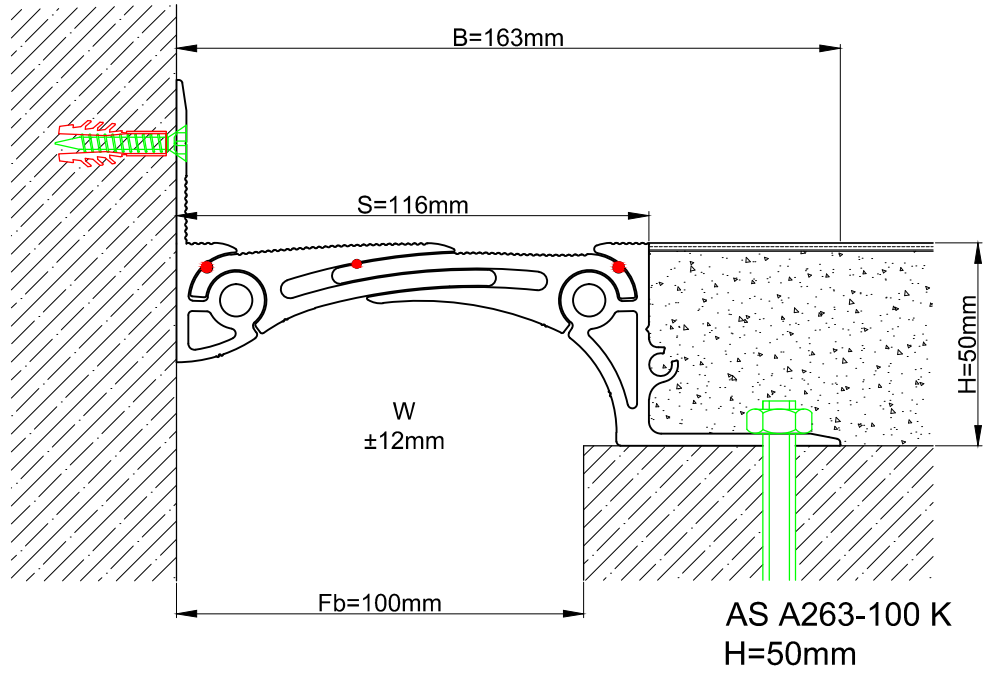

Patent No : TR 2010 06287B
 Patentli Profildir / Patented Profile

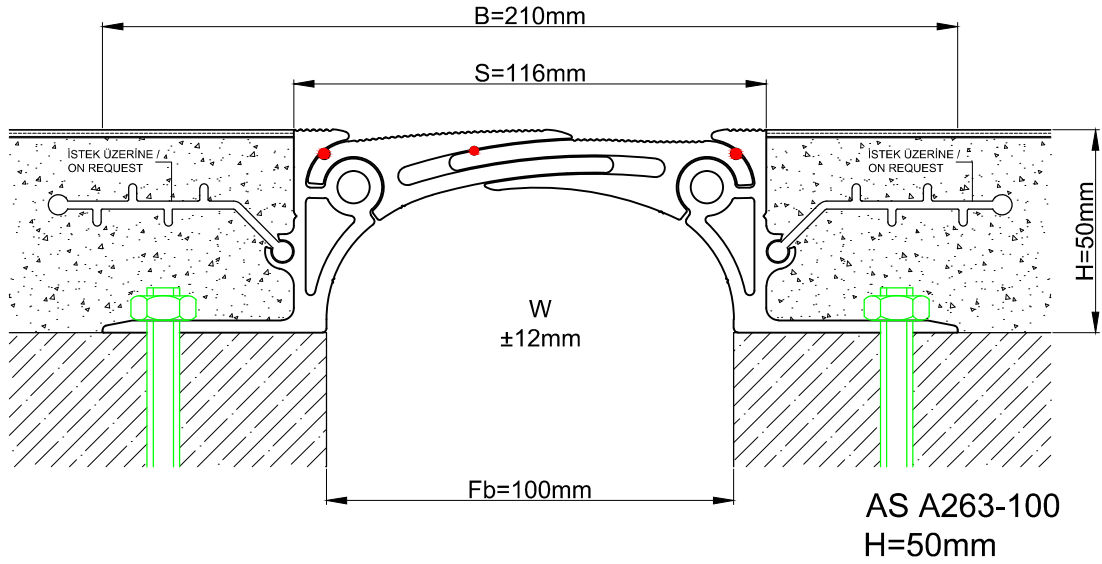

Profil No Profile Number	AS A263-100	AS A263-100 K
Fb (mm)	100	100
H (mm) yaklaşık approx.	50	50
W± (mm) yaklaşık approx.	±12	±12
Renk Color	Alüminyum: Natürel Aluminum: Natural	
Malzeme Material	Alüminyum Aluminum	
Standart Uzunluk (m) Standard Length (m)	3	
Yükleme Kapasitesi Load - Bearing Capacity	70 kN 	600 kN 